





LIPSA 2021 November USPSA Match

Stage 2 – The Zig

Course Designer: R. Esposito

**START POSITION:** Facing downrange, toes touching red mark on fault line. Hands naturally at sides.

**GUN READY CONDITION:** Pistol loaded and holstered IAW USPSA rules.

**PCC Start:** Stock touching belt, with muzzle pointed safely downrange.

**STAGE PROCEDURE:** Upon start signal, enter FFZ and engage all targets as they appear.

**SCORING:** Comstock, 17 rounds, 85 points

**TARGETS:** 8 paper, 1 steel

**SCORED HITS:** Best 2/paper; KD steel = 1A

**START-STOP:** Audible - Last shot

**RULES:** USPSA current edition

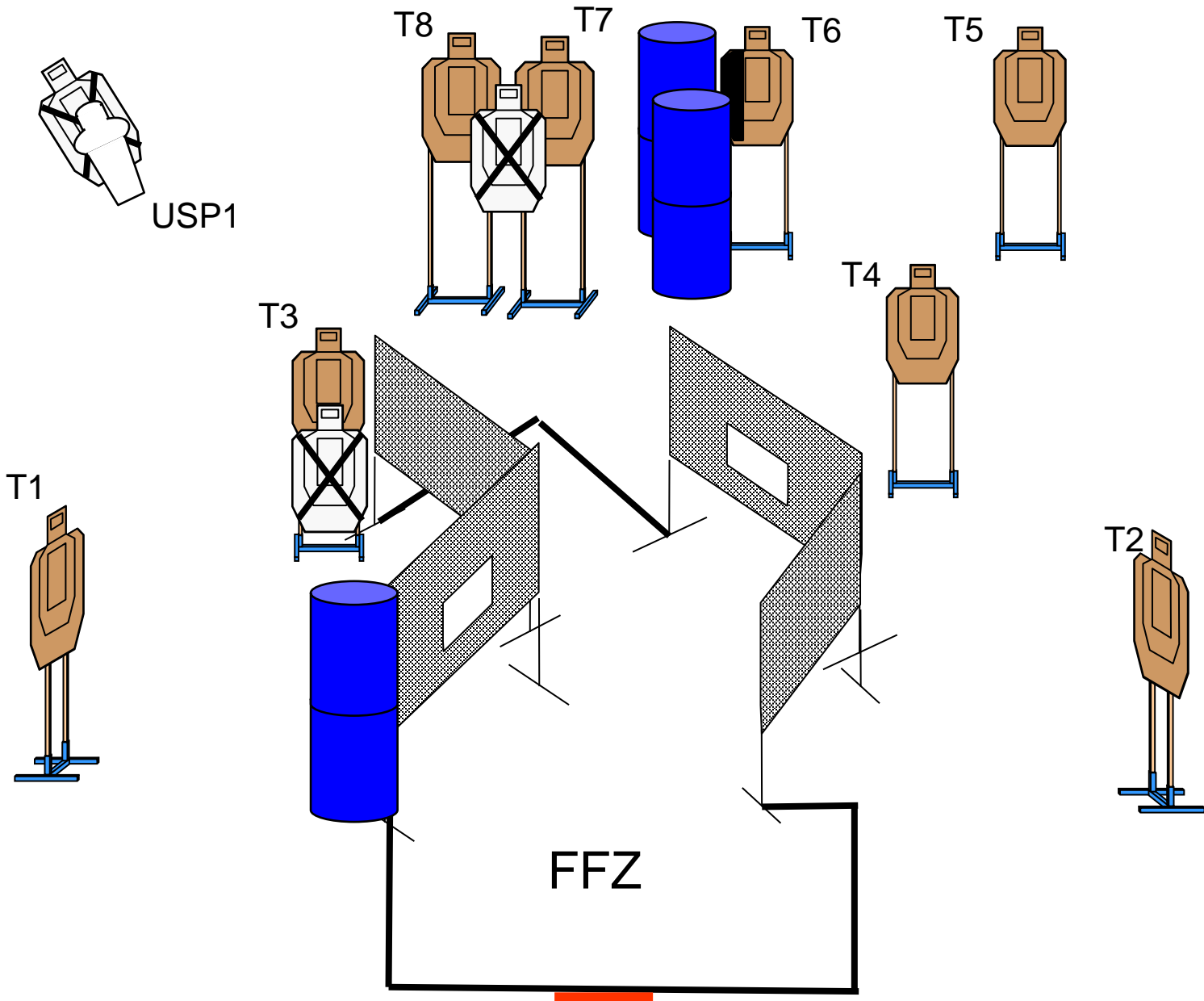



LIPSA 2021 November USPSA Match

Stage 3 – Alley Catz

Course Designer: R. Esposito

**START POSITION:** Standing behind barrel A or B, wrists above shoulders.

**GUN READY CONDITION:** Loaded pistol or PCC on barrel with muzzle pointed safely downrange.

**STAGE PROCEDURE:** Upon start signal engage all targets as they appear from within the FFZ.

**SCORING:** Comstock, 16 rounds, 80 points

**TARGETS:** 6 Paper, 4 steel

**SCORED HITS:** Best 2/paper; KD steel = 1A

**START-STOP:** Audible - Last shot

**RULES:** USPSA current edition

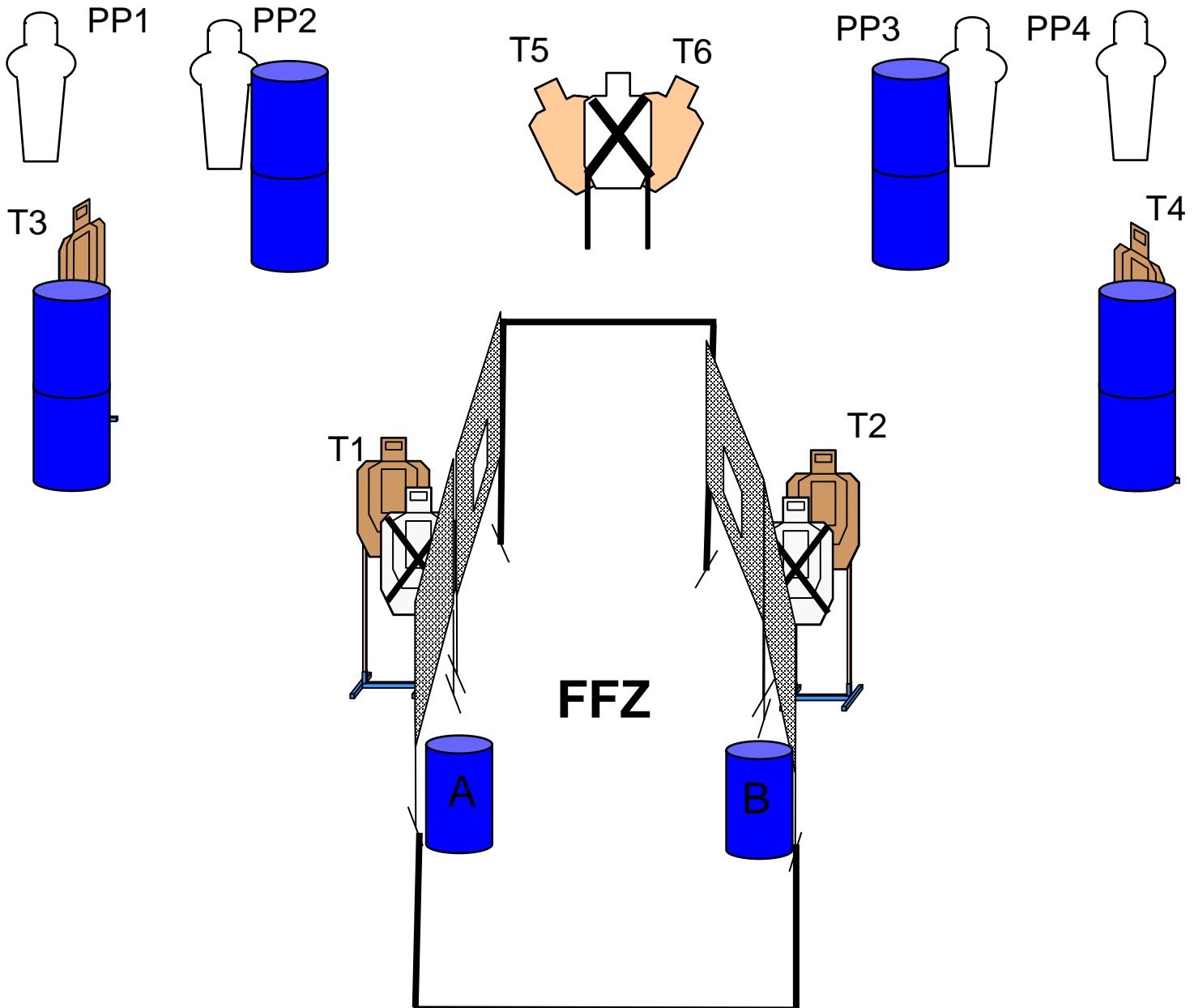



LIPSA 2021 November USPSA Match  
Stage 4 – 2012 US IPSC Nationals

Course Designer: Cliff

**START POSITION:** Standing in shooting area hands relaxed.

**GUN READY CONDITION:** Unloaded gun and all ammunition on the table.

**PCC Start :** Same start for PCC

**SCORING:** Comstock, 16 rounds, 80 points

**TARGETS:** 6 IPSC, 4 Steel

**SCORED HITS:** Best 2 per paper, KD steel = 1A

**START-STOP:** Audible - Last shot

**RULES:** USPSA current edition

**STAGE PROCEDURE:** Upon start signal, engage all targets from within the FFZ.

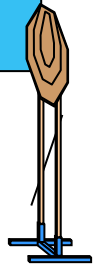
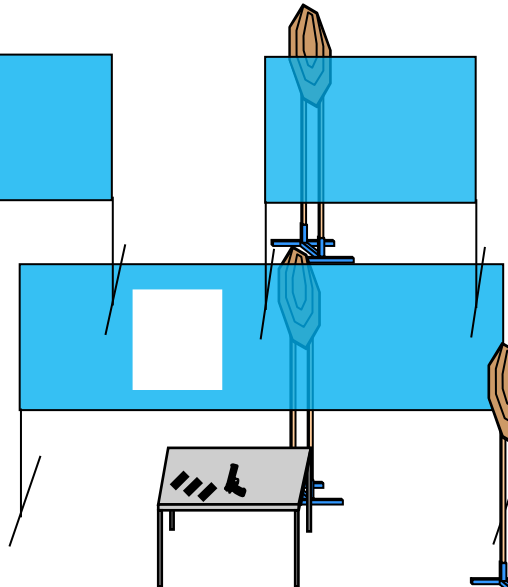
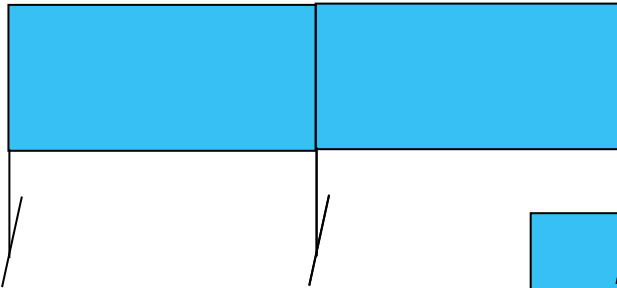
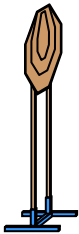
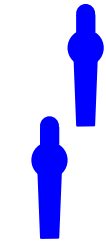
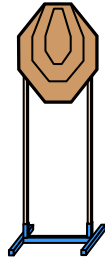
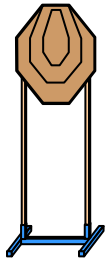

FFZ



**LIPSA 2021**  
**November USPSA Match**  
**Stage 5 – El Diablo II**  
**Stage Designer: R. Esposito**

**START POSITION:** Standing in Box A, facing downrange, hands naturally at sides

**GUN READY CONDITION:** Pistol loaded and holstered IAW USPSA rules.  
**PCC Start :** PCC loaded with stock touching belt.

**SCORING:** Virginia Count, 10 rds, 50 pts.  
**TARGETS:** 5 IPSC  
**SCORED HITS:** Best 2 per paper  
**START-STOP:** Audible - Last shot  
**RULES:** USPSA current edition

**STAGE PROCEDURE:**  
**String 1:** Upon start signal, engage T1 – T5 from Box A with 2 rounds each.

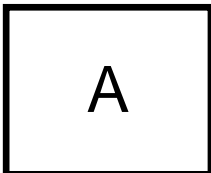
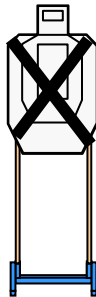
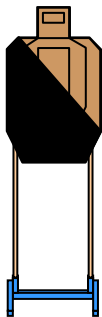
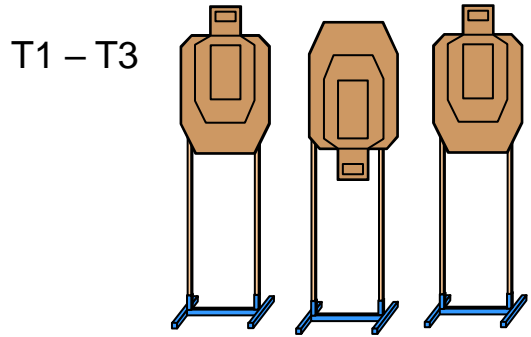

Pit 5, Stage 5

Note: Place T1-T3 20-25 Yds. from Box A

**CM 19-01 HI-JINX**  
**Course Designer: David Jenkins**  
**Rules: Per USPSA Rules**

**START POSITION:** Standing in the shooting area. Wrists below belt

**GUN READY CONDITION:** Loaded and holstered

**SCORING:** Comstock, 12 rounds  
**TARGETS:** 6 USPSA

**STAGE PROCEDURE:** On signal, engage targets as available.

**SCORED HITS:** Best 2  
**START-STOP:** Audible - Last shot  
**RULES:** Per USPSA rules

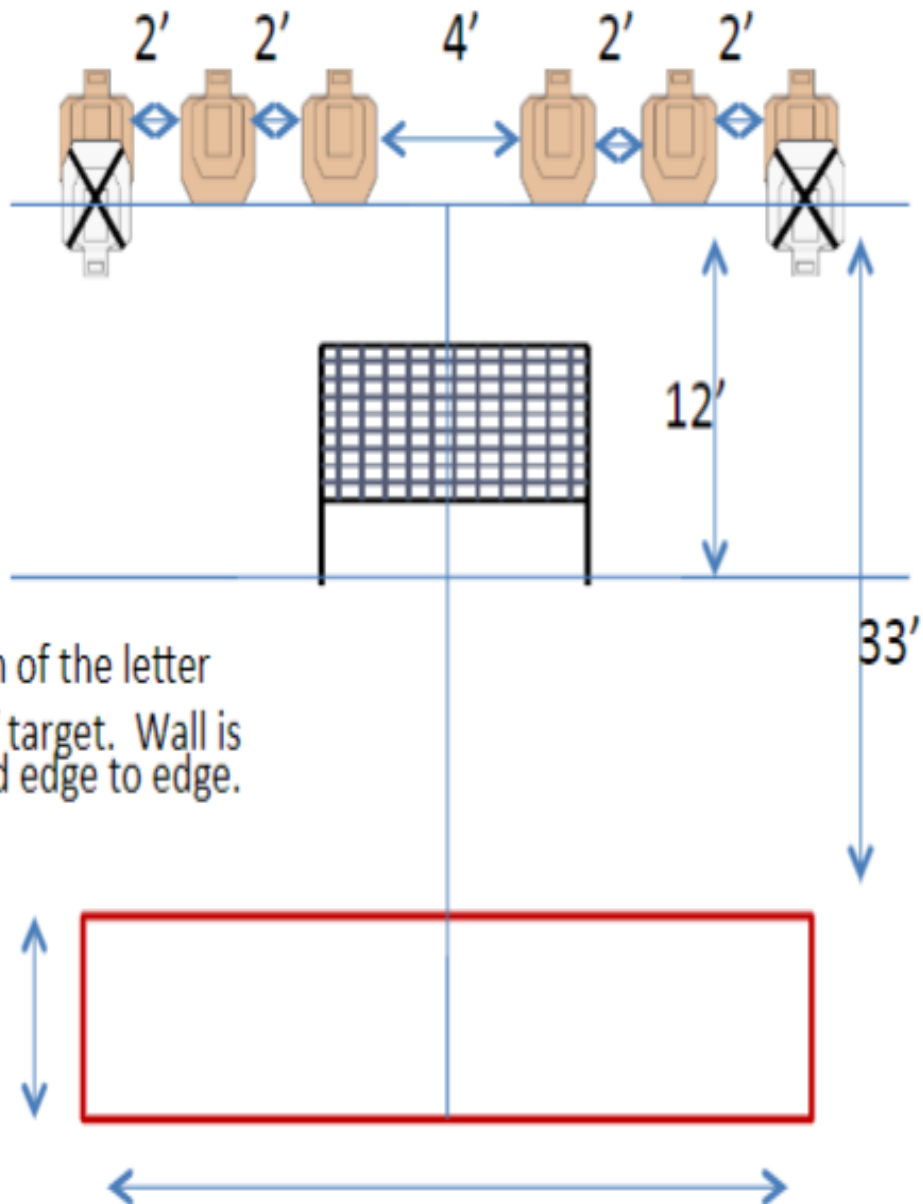

NS even with the bottom of the letter "A". 5' to top of head of target. Wall is 8'x 6'. Targets are spaced edge to edge.

## CM 19-01      HI-Jinx

### Written Stage Briefing

HI Jinx is a 12 round, 60-point, Comstock Short Course. There are 6 USPSA targets. The best 2 hits per cardboard will score.

The handgun start position is standing anywhere inside the shooting area, wrists below belt with handgun loaded and holstered.

The PCC start position is standing anywhere inside shooting area, holding loaded PCC with safety on, stock on belt, muzzle pointing downrange.

On the audible start signal, engage targets as they become available from within the shooting area.





LIPSA 2021 November USPSA Match

Stage 7 – The ZAG

Course Designer: R. Esposito

**START POSITION:** Standing behind table, facing downrange, hands naturally at sides

**GUN READY CONDITION:** Unloaded pistol and 1<sup>st</sup> mag on table IAW USPSA rules.

**PCC Start:** Unloaded PCC and 1<sup>st</sup> mag on table with muzzle pointed safely downrange IAW USPSA rules.

**STAGE PROCEDURE:** Upon start signal engage all targets as they appear from within the FFZ.

**SCORING:** Comstock, 16 rounds, 80 points  
**TARGETS:** 7 Paper; 2 steel  
**SCORED HITS:** Best 2 hits/paper, KD steel = 1A  
**START-STOP:** Audible - Last shot  
**RULES:** USPSA current edition

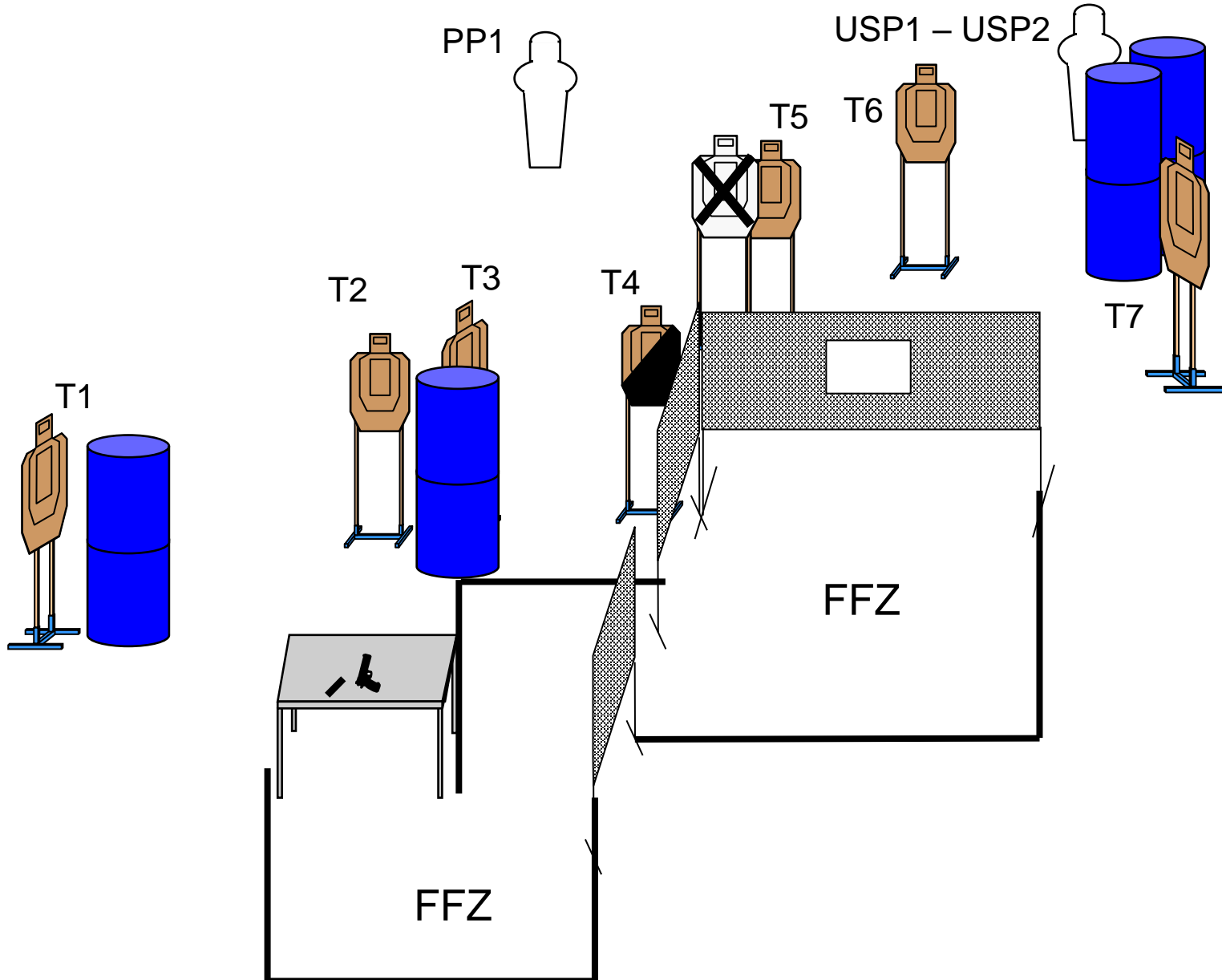

Pit 6 stage 7





LIPSA 2021 November USPSA Match

Stage 8 – Out of Reach

Course Designer: R. Esposito

**START POSITION:** Standing behind table, facing downrange, toes touching red mark on fault line. Wrists below belt..

**GUN READY CONDITION:** Loaded gun on table with muzzle pointed safely downrange IAW USPSA rules.  
**PCC Start:** Same as above.

**SCORING:** Comstock, 17 rounds, 85 points  
**TARGETS:** 7 paper, 3 steel  
**SCORED HITS:** Best 2 hits/paper, KD steel = 1A  
**START-STOP:** Audible - Last shot  
**RULES:** USPSA current edition

**STAGE PROCEDURE:** Upon start signal, retrieve gun and engage all targets as they appear from within the FFZ.

