

My House

Stage 1

START POSITION: Standing in box A, Gun loaded at ready and muzzle touching x on barrel

STAGE PROCEDURE:

At signal enter house and engage T1-T9 from inside house

SCORING:

Comstock 18 rounds

Targets: 9 IPSC

Scored Hits: Best 2 per Target

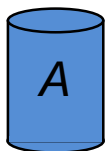
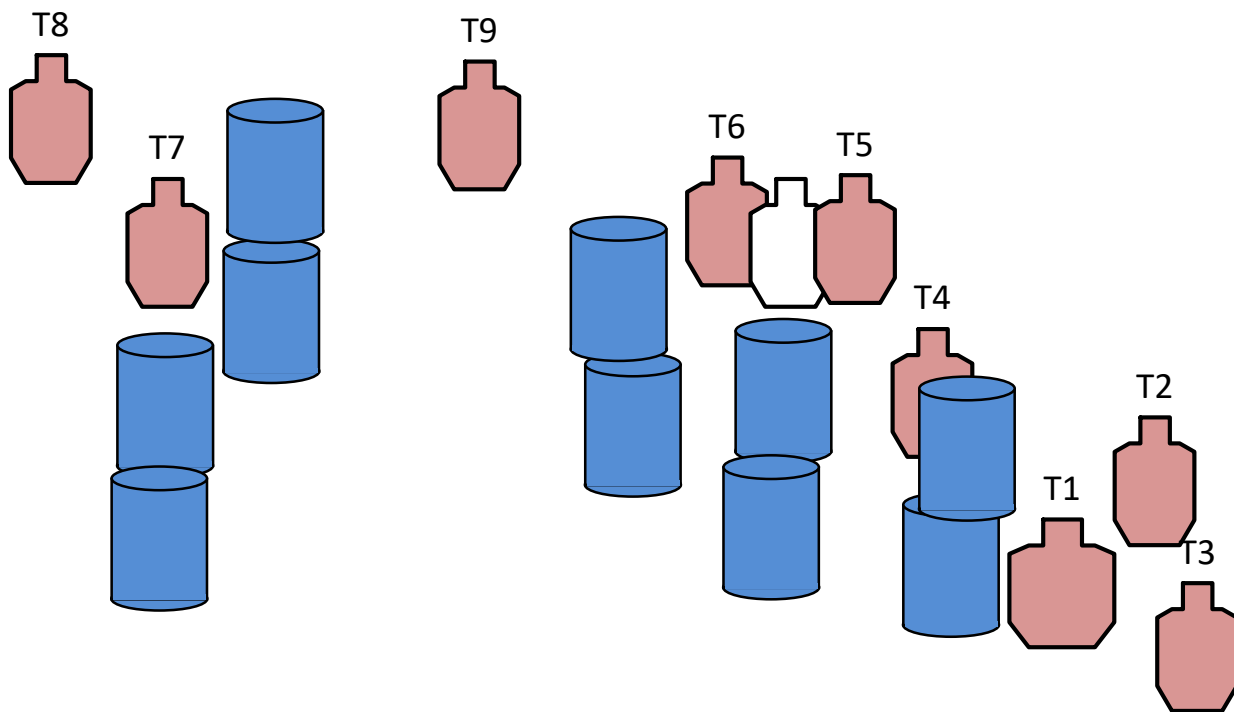

In the street

Stage 2

START POSITION: Standing in box A, Gun loaded at ready and muzzle touching x on barrel

STAGE PROCEDURE:

At signal, engage targets as they become visible. Within free fire zone,

SCORING: Comstock 18 rounds

Targets: 9 IPSC

Scored Hits: Best 2 per Target

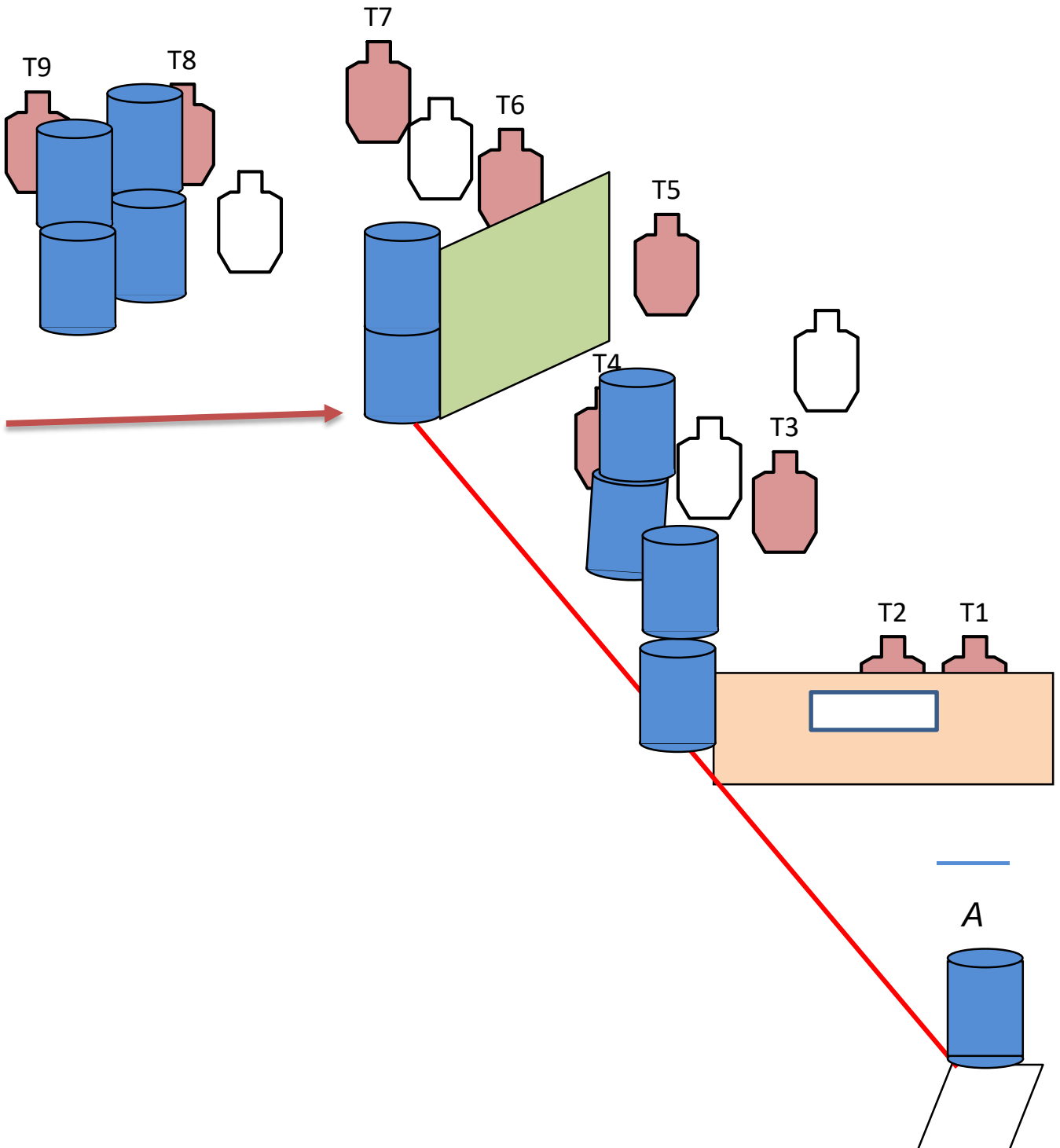

Left Center right

Stage 3

START POSITION: Standing in box A, Gun loaded at ready and muzzle touching x on barrel

STAGE PROCEDURE:

At signal, engage targets as they become visible. Within free fire zone, all targets must be shot thru ports

SCORING: Comstock 18 rounds

Targets: 9 IPSC

Scored Hits: Best 2 per Target

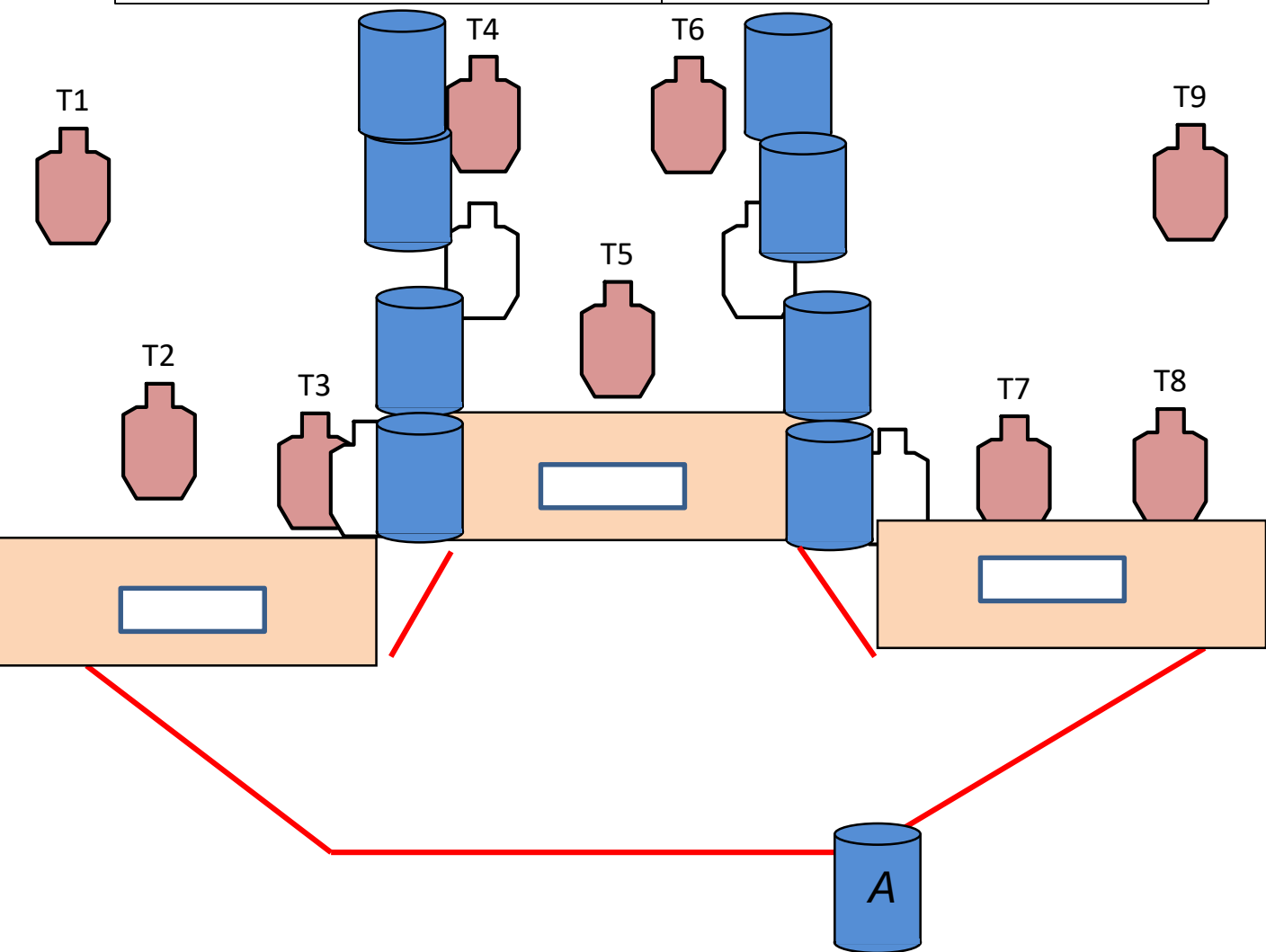

I got it

Stage 4

START POSITION: Standing in box A, Gun loaded at ready and muzzle touching x on barrel

STAGE PROCEDURE:

At signal, engage targets as they become visible. Within free fire zone

SCORING: Comstock 16 rounds

Targets: 8 IPSC

Scored Hits: Best 2 per Target

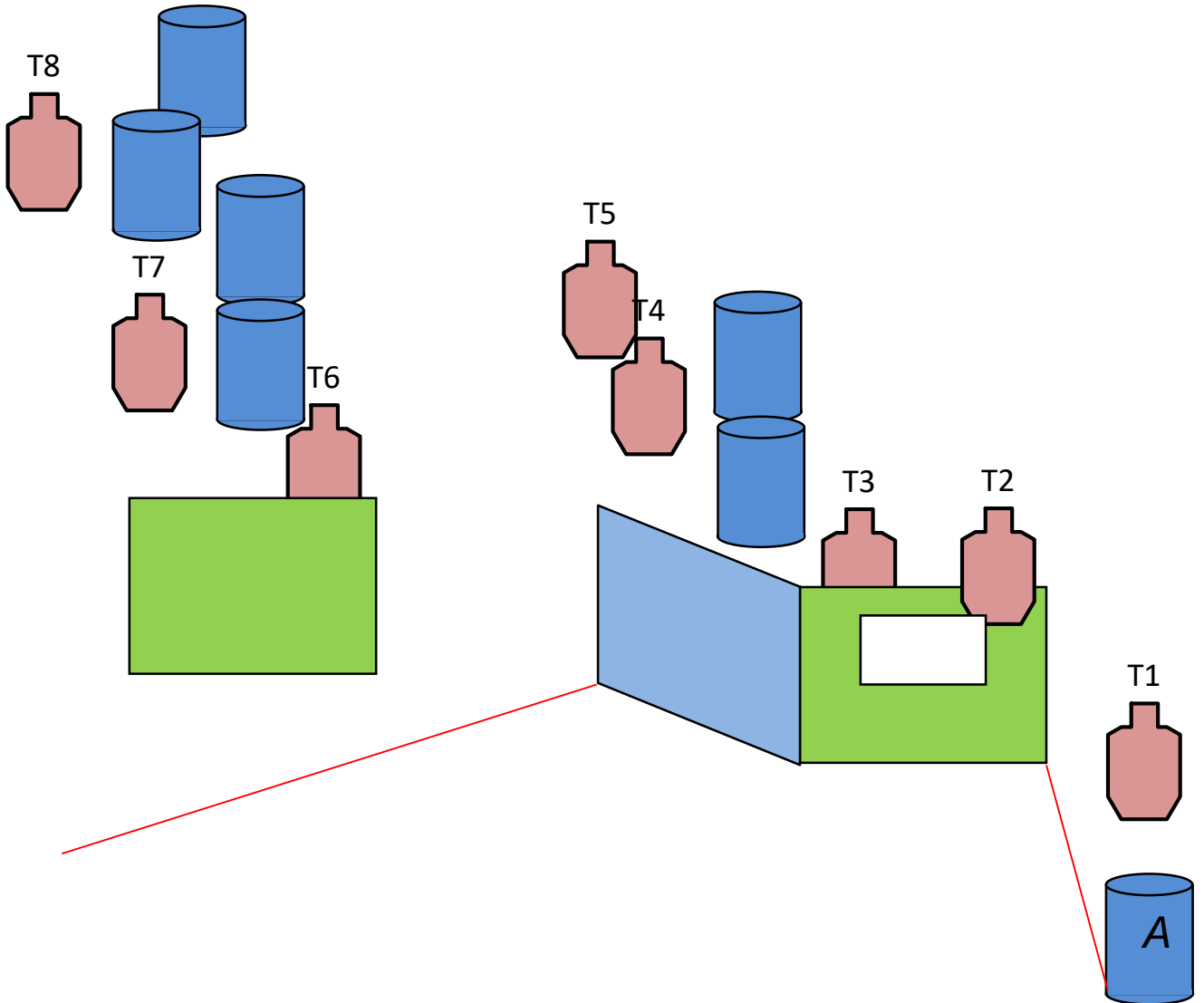

There you are

Stage 5

START POSITION: Standing in box A, Gun loaded at ready and muzzle touching x on barrel

STAGE PROCEDURE:

At signal, engage Targets as they become visible. Within free fire zone

SCORING: Comstock 16 rounds

Targets: 8 IPSC

Scored Hits: Best 2 per Target

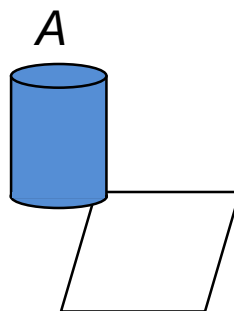
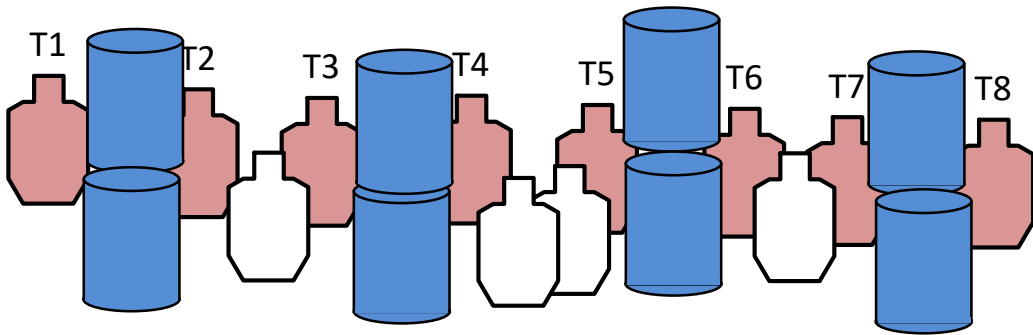

Dem

Stage 6

RULES: Practical shooting handbook, latest edition

START POSITION: Standing in box A, Gun loaded at ready and muzzle touching x on barrel

STAGE PROCEDURE:

At signal, engage targets as they become visible. Within free fire zone

SCORING: Comstock 20 rounds
Targets: 10 IPSC
Scored Hits: Best 2 per Target
Start/Stop: Audible/Last shot
Penalties: Procedural -10
No-shoot-10
Miss-10

