



# LIPSA

# The Dillon Way

Special Thanks: Dillon Precision

RULES: Practical Shooting Handbook, Latest Edition Course Designer: **Michael Linsalata**

**START POSITION:** Standing anywhere in shooting area, wrists below belt. Gun loaded and holstered.  
PCC start is gun loaded. Safety on. Muzzle pointed down range. Butt touching belt.

STAGE PROCEDURE	SCORING
At signal, engage all targets and steel as they become visible from within the fault lines.	<b>SCORING:</b> Comstock, 24 rounds, 120 points <b>TARGETS:</b> 9 USPSA, 6 steel <b>SCORED HITS:</b> Best 2 per USPSA <b>START-STOP:</b> Audible-Last Shot

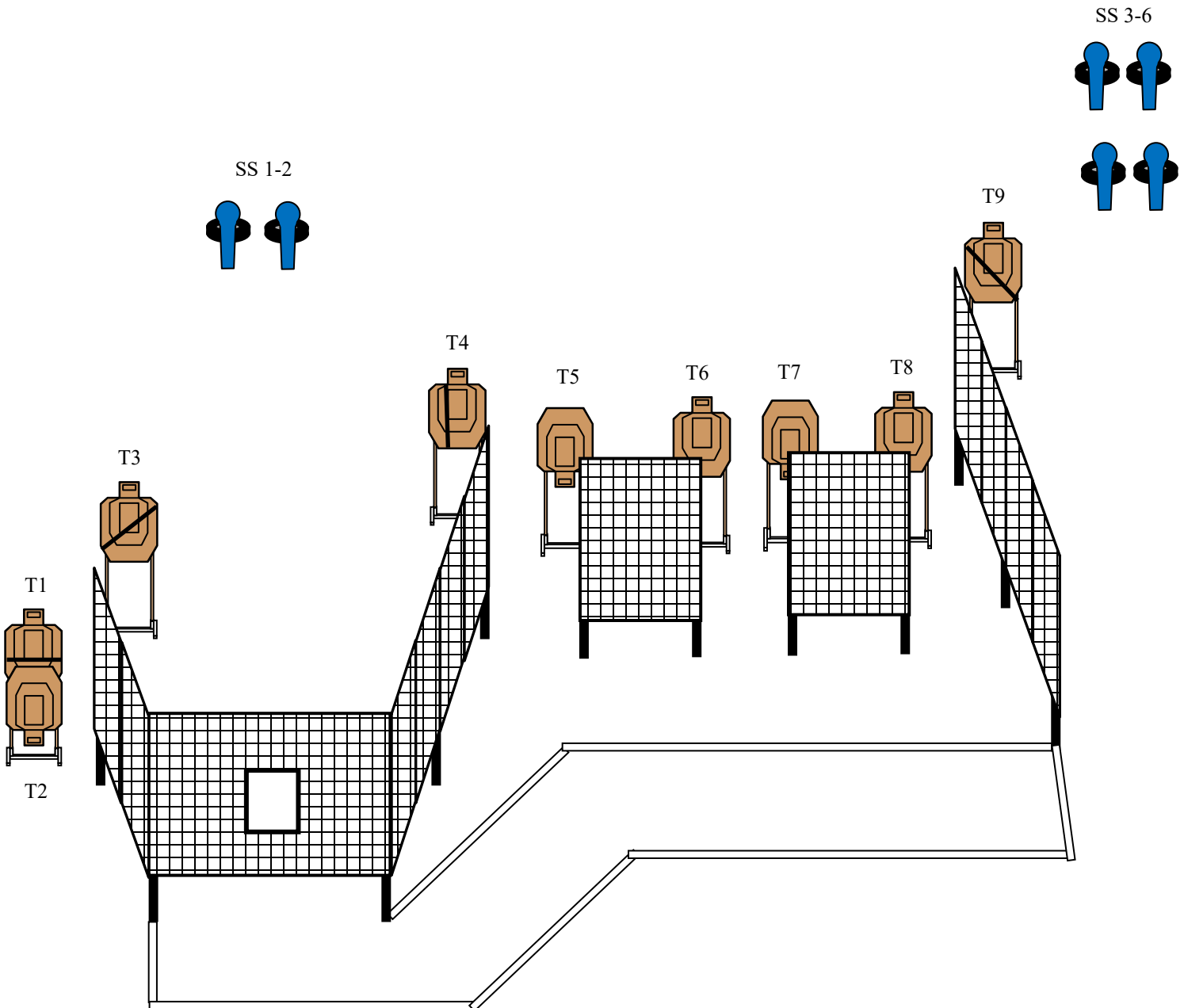

**Stage 1**



**LIPSA**

# Nisa's Star

Special Thanks: Nisa

**RULES:** Practical Shooting Handbook, Latest Edition **Course Designer: Michael Linsalata**

**START POSITION:** Standing anywhere in shooting area, wrists below belt. Gun loaded and holstered.  
PCC start is gun loaded. Safety on. Muzzle pointed down range. Butt touching belt.

### STAGE PROCEDURE

At signal, engage all targets and steel as they become visible from within the shooting area.

### SCORING

**SCORING:** Comstock, 23 rounds, 115 points  
**TARGETS:** 9 USPSA, 5 steel  
**SCORED HITS:** Best 2 per USPSA, Steel Down = 1A  
**START-STOP:** Audible-Last Shot

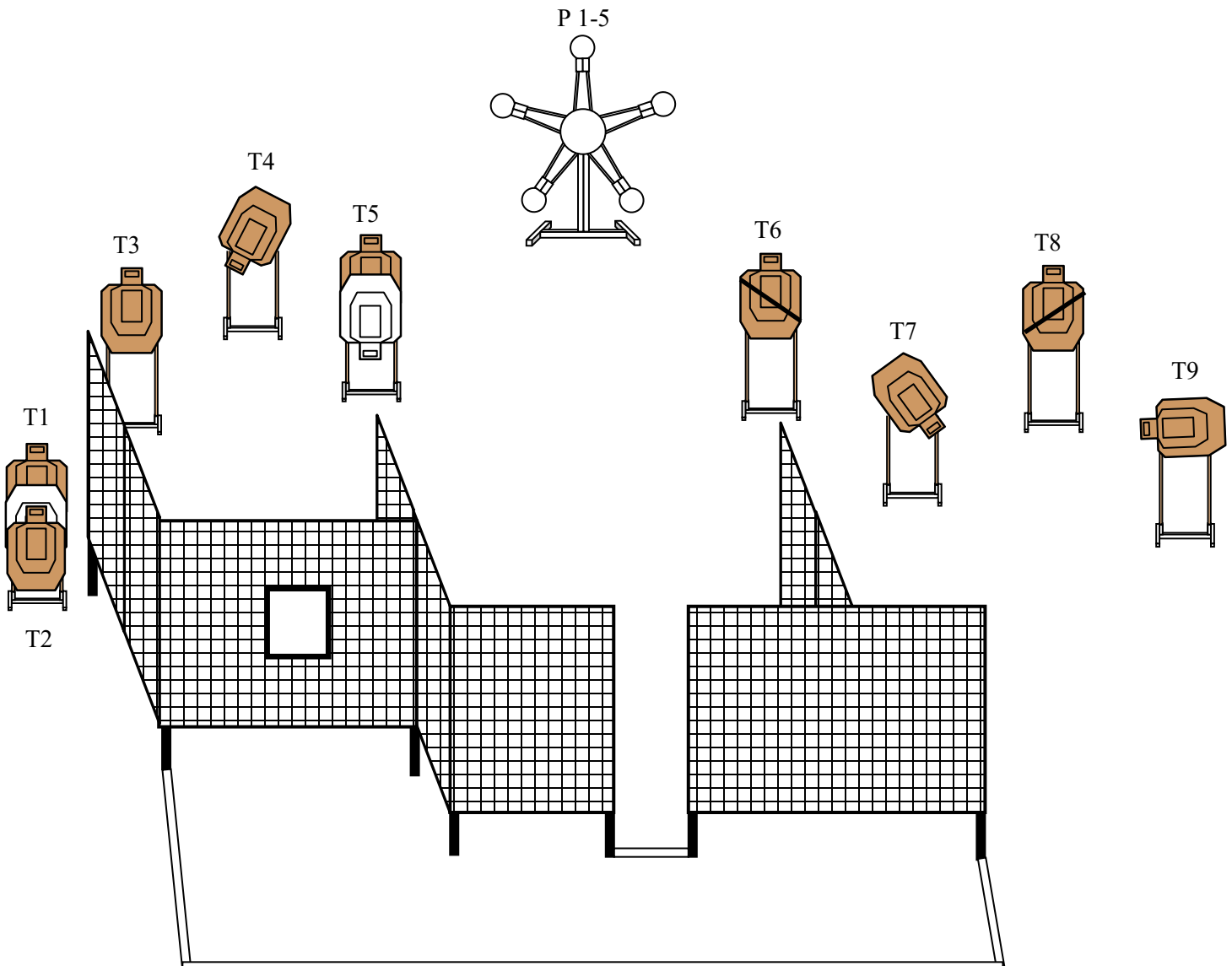

**Stage 2**



**LIPSA**

# Jason's Stage

Special Thanks: Some guy named Jason

RULES: Practical Shooting Handbook, Latest Edition Course Designer: **Michael Linsalata**

## STAGE PROCEDURE

At signal, engage all targets and steel as they become visible from within the fault lines. **(PP1 activates no shoot in front of T5 (Max Trap). It must be activated before engaging T5).**

## SCORING

**SCORING:** Comstock, 26 rounds, 130 points

**TARGETS:** 9 USPSA, 8 steel

**SCORED HITS:** Best 2 per USPSA, steel down =1A

**START-STOP:** Audible-Last Shot

**START POSITION:** Standing anywhere in shooting area, wrists below belt. Gun loaded and holstered. PCC start is gun loaded. Safety on. Muzzle pointed down range. Butt touching belt.

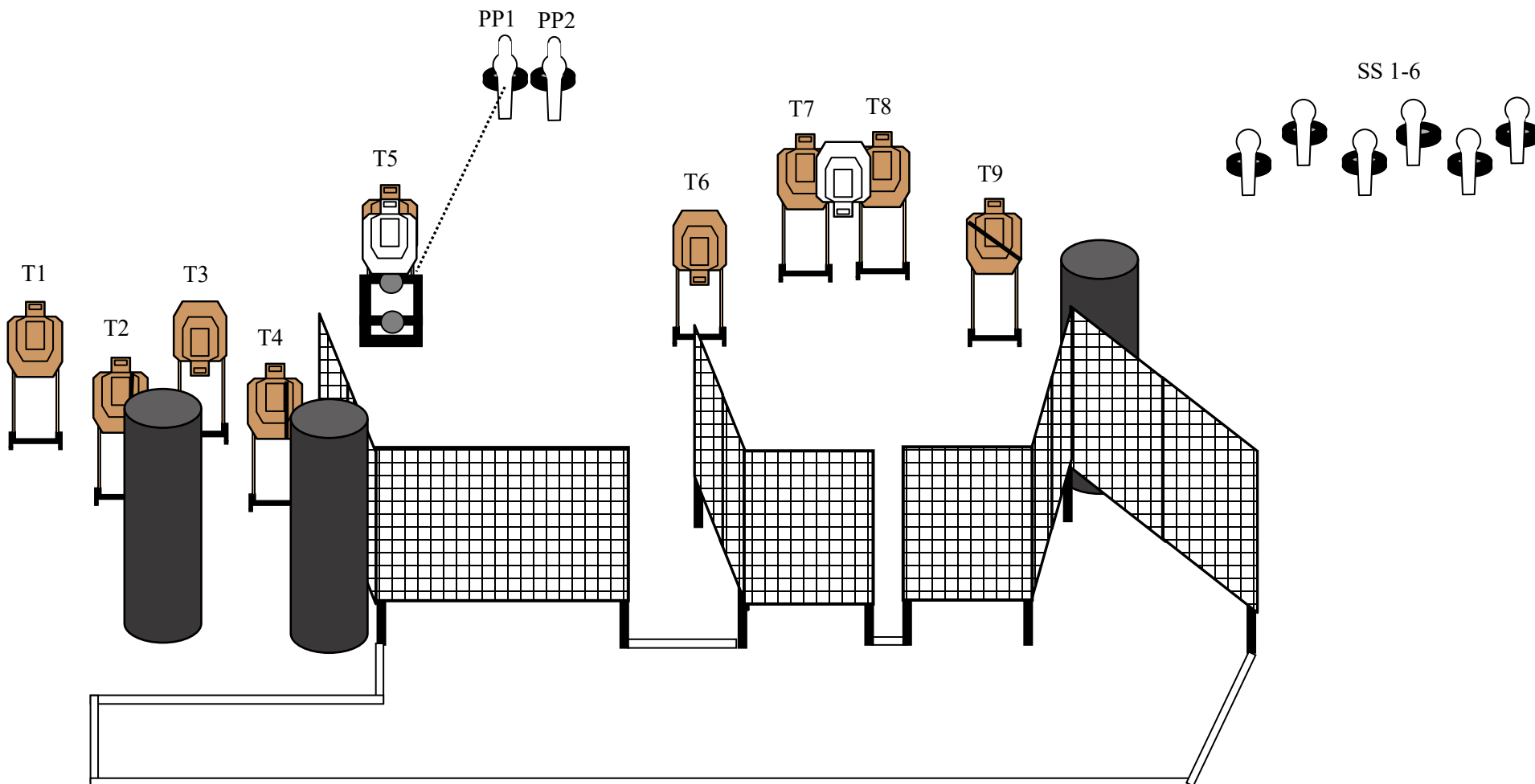

**Stage 3**



**LIPSA**

# Cobra County

Special Thanks: Some other guy on Facebook, Cobra\_Jack

**RULES:** Practical Shooting Handbook, Latest Edition **Course Designer: Michael Linsalata**

**START POSITION:** Standing with heels touching **RED** mark, wrists below belt. Loaded gun on table.  
Extra mags carried on belt. PCC has same start position

### STAGE PROCEDURE

At signal, pick up loaded gun from table. Then engage all targets and steel as they become visible from the shooting area.

### SCORING

<b>SCORING:</b>	Comstock, 24 rounds, 120 points
<b>TARGETS:</b>	9 USPSA, 6 steel
<b>SCORED HITS:</b>	Best 2 per USPSA, Steel Down = 1A
<b>START-STOP:</b>	Audible-Last Shot

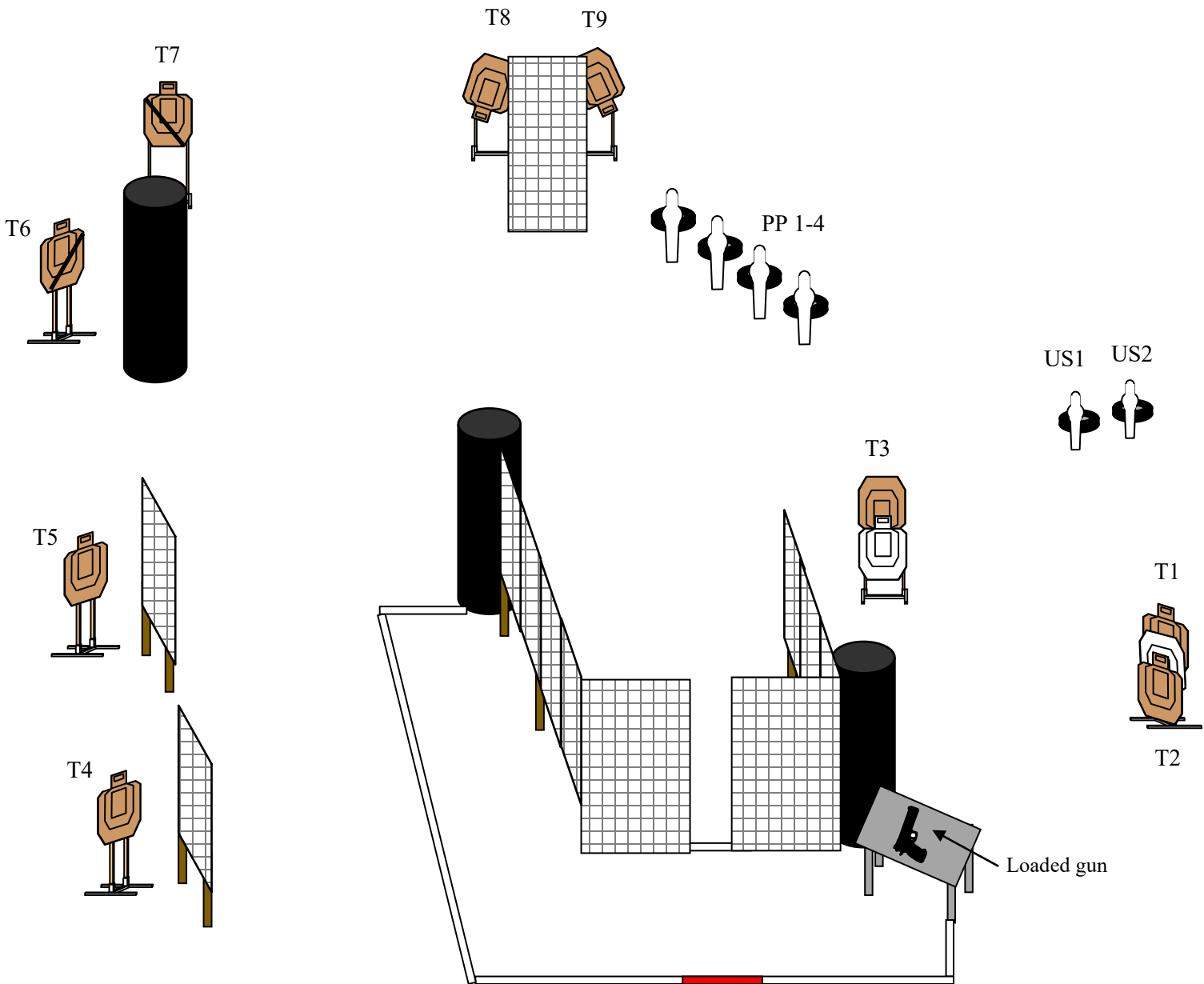

**Stage 4**



# LIPSA

# Sal's Turtles

Special Thanks:

**RULES:** Practical Shooting Handbook, Latest Edition **Course Designer: Sal Amato**

**START POSITION:** Standing with toes touching **RED** mark, wrists below belt. Gun loaded and holstered. PCC start is gun loaded, safety on. Pointing down range. Butt touching belt.

### STAGE PROCEDURE

At signal, engage all targets as they become visible from within the fault lines.

### SCORING

**SCORING:** Comstock, 28 rounds, 140 points  
**TARGETS:** 14 IPSC  
**SCORED HITS:** Best 2 per IPSC  
**START-STOP:** Audible-Last Shot

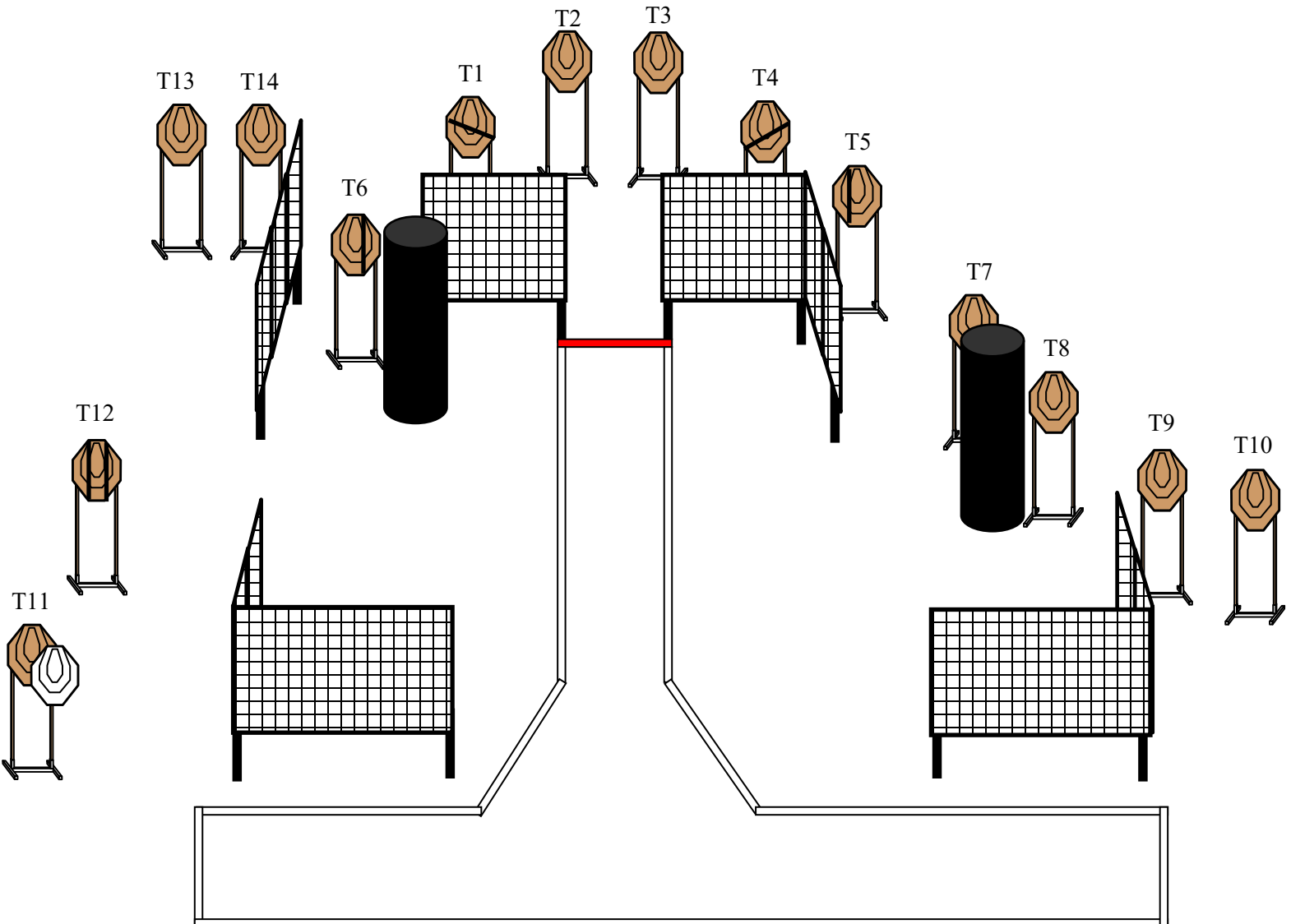



# LIPSA

# Line 'Em Up 2

Special Thanks: Line 'Em Up

RULES: Practical Shooting Handbook, Latest Edition Course Designer: **Michael Linsalata**

**START POSITION:** Standing with palms flat on **X's**. Gun loaded and holstered. PCC start is gun loaded. Safety on. Muzzle touching mark on barrel.

### STAGE PROCEDURE

At signal, engage all targets and steel as they become visible from within the fault lines. (PP2 activates T9. (Disappearing target). T9 must be activated before engaging).

### SCORING

**SCORING:** Comstock, 22 rounds, 110 points  
**TARGETS:** 9 USPSA, 4 steel  
**SCORED HITS:** Best 2 per USPSA, Steel Down= 1A  
**START-STOP:** Audible-Last Shot

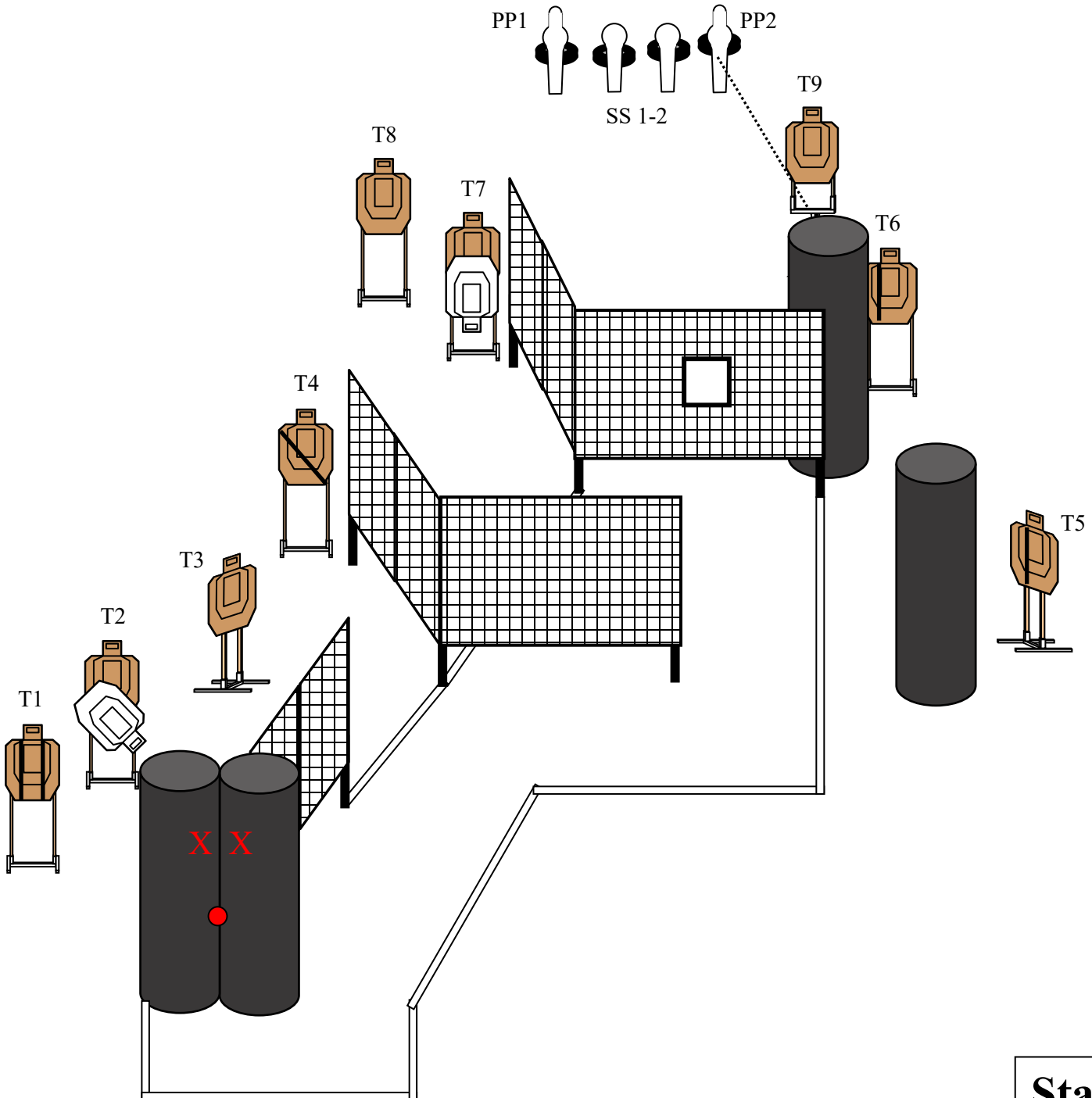



# LIPSA

# Nine

Special Thanks:

RULES: Practical Shooting Handbook, Latest Edition Course Designer: **Michael Linsalata**

**START POSITION:** Standing anywhere in shooting Area, wrists below belt. Gun loaded and holstered.  
PCC start is gun loaded, safety on. Muzzle pointing down range. Butt touching belt.

### STAGE PROCEDURE

At signal, engage all targets and steel as they become visible from within the shooting area.

### SCORING

**SCORING:** Comstock, 9 rounds, 45 points  
**TARGETS:** 4 IPSC, 1 steel  
**SCORED HITS:** Best 2 per IPSC, Steel Down = 1A  
**START-STOP:** Audible-Last Shot

SS1

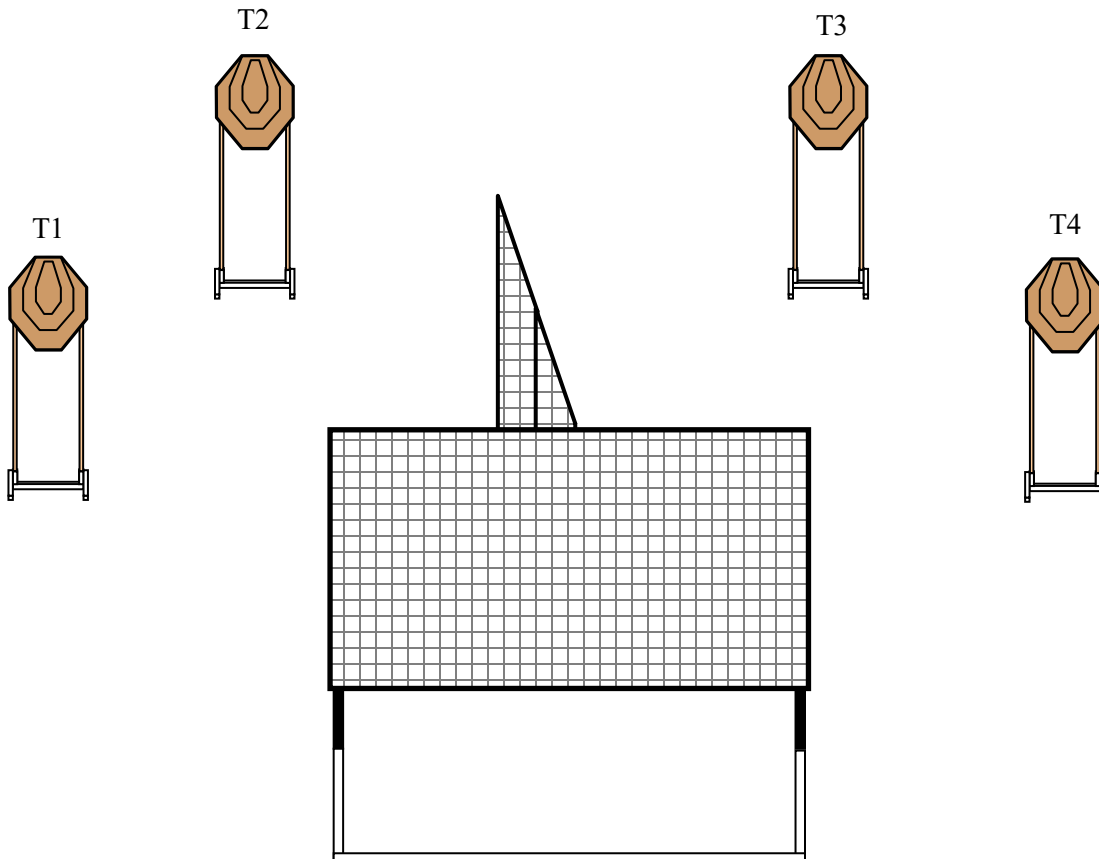

**Stage 7**  
**(Pit 7)**



# LIPSA

# 6 Is Enough

Special Thanks:

RULES: Practical Shooting Handbook, Latest Edition Course Designer: **Michael Linsalata**

**START POSITION:** Standing anywhere in shooting area, wrists above shoulders. Gun loaded and holstered. PCC start is gun loaded, safety on. Held in strong hand with butt on belt. Weak wrist above shoulder.

### STAGE PROCEDURE

At signal, engage all targets and steel as they become visible from within the shooting area.

**PP1 activates T1 (Bobber). T1 must be activated before being engaged.**

### SCORING

**SCORING:** Comstock, 6 rounds, 30 points

**TARGETS:** 2 USPSA, 2 steel

**SCORED HITS:** Best 2 per USPSA, Steel Down = 1A

**START-STOP:** Audible-Last Shot

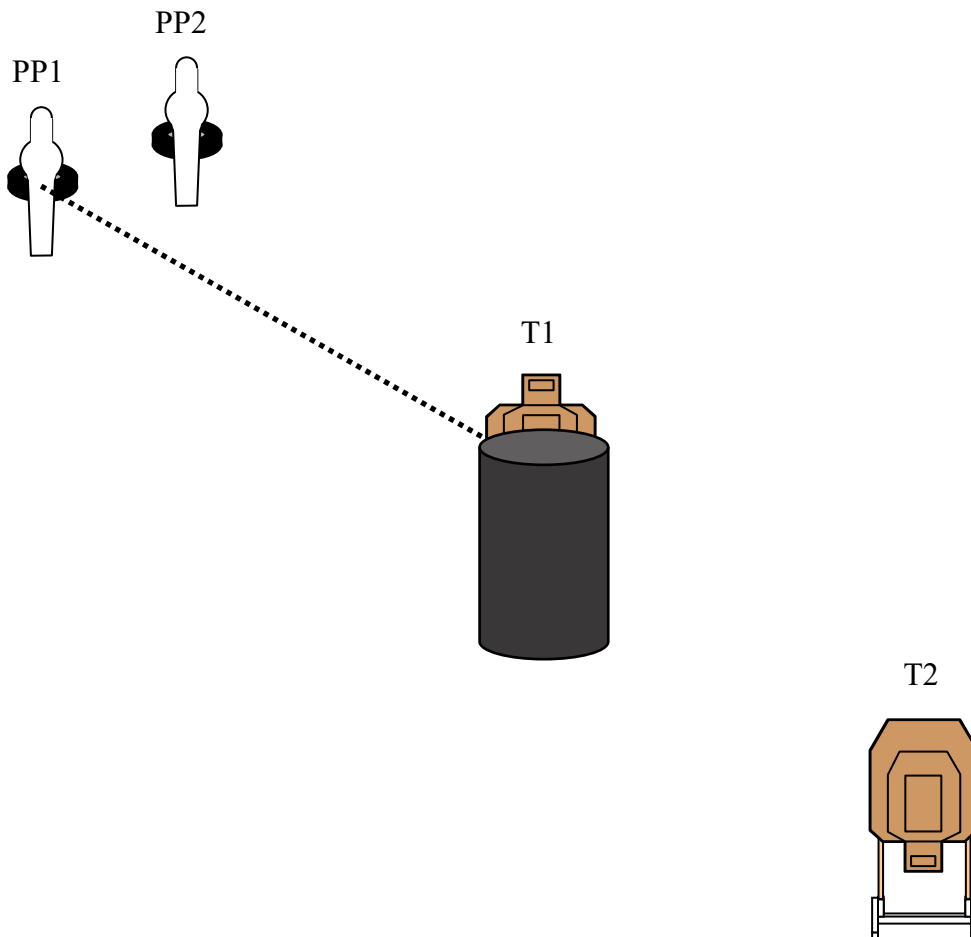

**Stage 8**  
**(Pit 7)**





**LIPSA**

# Down Bill's Hallway

Special Thanks: Bill Rodgers

RULES: Practical Shooting Handbook, Latest Edition Course Designer: **Michael Linsalata**

**START POSITION:** Standing with toes touching **RED** mark, wrists below belt. Gun loaded and holstered. PCC start is gun loaded. Safety on. Muzzle pointed down range. Butt touching belt.

## STAGE PROCEDURE

At signal, engage all targets and steel as they become visible from within the shooting area.

## SCORING

**SCORING:** Comstock, 27 rounds, 135 points  
**TARGETS:** 10 IPSC, 7 steel  
**SCORED HITS:** Best 2 per IPSC, Steel Down= 1A  
**START-STOP:** Audible-Last Shot

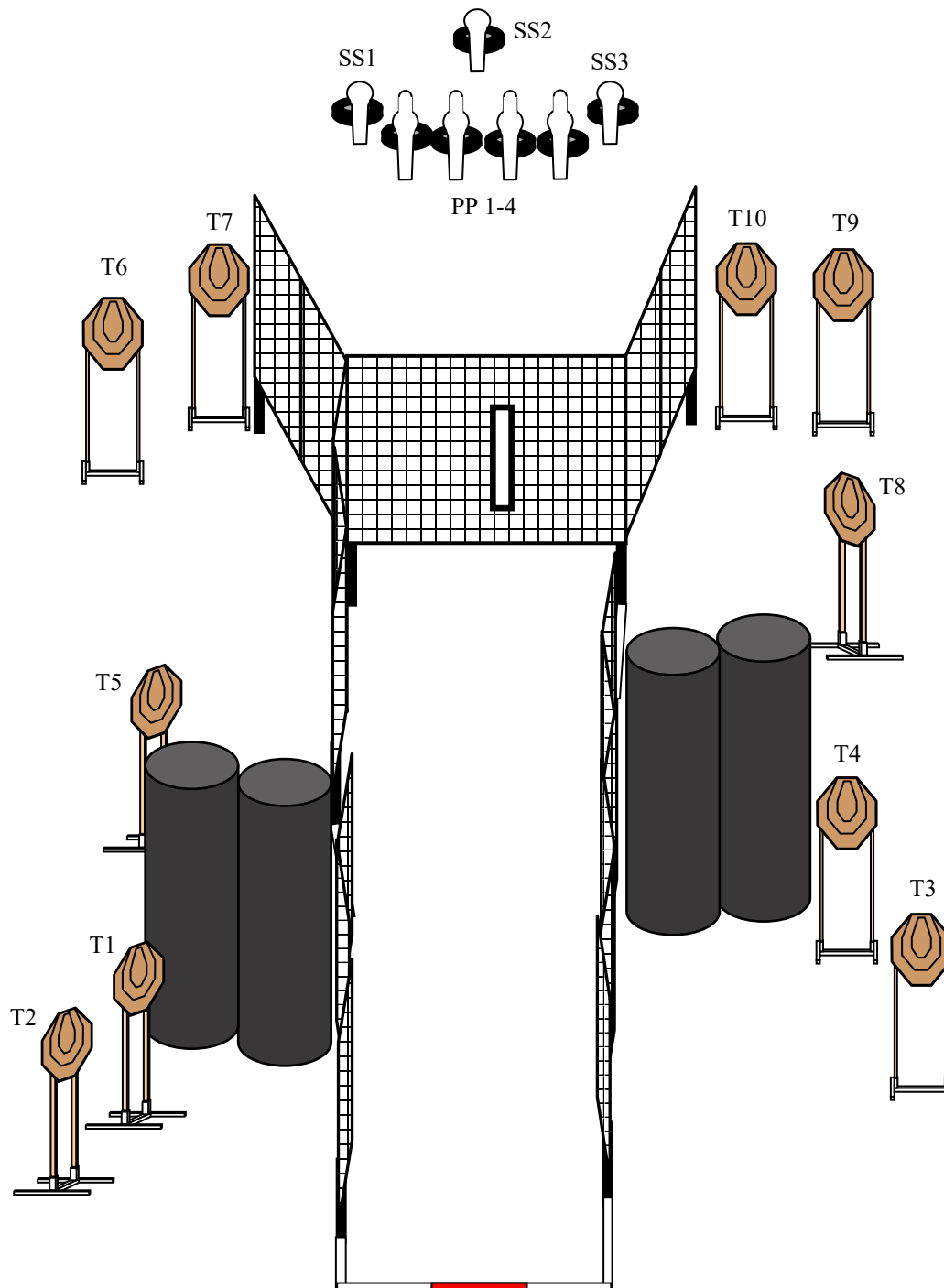

**Stage 9**  
**(Pit 8)**